



MHT MOLD & HOTRUNNER
TECHNOLOGY AG



PET Preform Molds

 German
Technology

Who We Are

MHT Mold & Hotrunner Technology AG was established in 1996. Since then we have been supplying the global market with high performance PET molds and hotrunner products. Our team consists of 125 employees and we own three production and service facilities which are located in Germany, Brazil, and the USA.

Up to now MHT has shipped over 2200 molds and spare parts to more than 100 countries. Partners and agents in Europe, America, Africa, the Middle East, Asia, and Australia provide a perfect service for our customers.



- 2019 New hotrunner generation
- 2018 MHT reinforces the Krones Group
- 2017 Presentation of Vulcan II hotrunner components
- 2015 Close cooperation with Sacmi
- 2013 72 cavities for HyPET 225 and 48 cavities for HyPET 120
- 2012 Presentation of 144 cavity mold for HyPET 500 and presentation of Vulcan I hotrunner components
- 2011 Design of the 112 cavity mold for KraussMaffei PETForm 350
- 2010 Introduction of upgrade set: 96 cavity mold for HyPET 300 and 128 cavity mold for HyPET 400
- 2008 First 128 cavity mold for 3,500 kN machines
- 2006 Foundation of MHT USA, Presentation of MHThpSTACK
- 2004 Presentation of first 192 cavity mold
- 2001 Presentation of first 144 cavity mold worldwide
- 2000 New production facility in Hochheim/Main
- 1998 Presentation of the first vertical PET systems
- 1996 Foundation of MHT by 11 partners



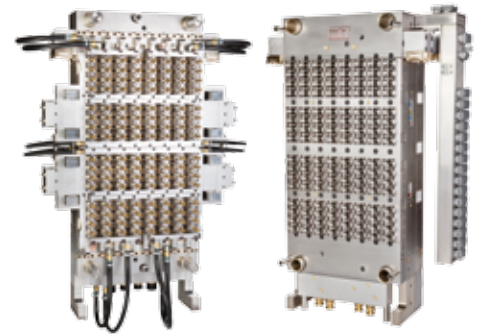
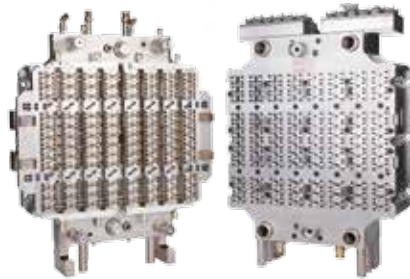
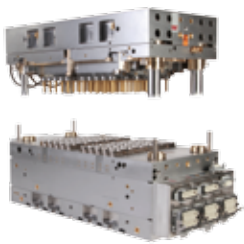

MAXIMUM CAVITATION

MHT molds are compatible with all high quality PET injection molding machines, and MHT has always been the one to take mold cavitations to the next limit. This makes us an ideal supplier and gives you more independence and flexibility.

The upgrade set for HyPET machines is offered within the context of a mold exchange or conversion. MHT assumes the complete project management and guarantees a smooth running changeover to the new mold design.

We build molds and post mold cooling solutions for **Sacmi | Husky | Netstal | KraussMaffei | Niigon | Sumitomo | Milacron | BMB**

Hot fill? Wide mouth? Low thread? We make it possible!

Cavities	For machine type
192	Netstal PET-LINE 6000
160	Husky HyPET 500, G-Line 600
144	Netstal PET-LINE 5000
128	Netstal PET-LINE 3500, Husky HyPET 400, Sacmi IPS 400
112	KraussMaffei PETForm 350
96	KraussMaffei PETForm 320, Husky HyPET 300
72	KM 300, HyPET 225, Netstal 2400, Sacmi IPS 220D, Niigon 300
60	Netstal PET-LINE 2000, KraussMaffei PF 175
48	Husky HyPET 120, Niigon 150 PET



Your Benefit

How many preforms do you want to produce?

Which design, what weight?

How big is the clamp force of your machine?

MHT PREFORM MOLDS

- Molds for all well known PET systems
- Complete conversions
- Weight and low thread conversions
- Mold refurbishments
- Mold and hotrunner spare parts
- Installation, service and repair of molds
- Customized training

HIGH QUALITY PREFORMS

- No crystallinity
- No scratches
- High quality surface
- Low acetaldehyde (AA) level
- Minimum eccentricity
- Dimensional stability
- Consistent weight
- No flash on split lines

No matter what the requirements are, we build the perfect mold for your project!



Innovative Strength

MHT is well known throughout the PET industry for its innovative strength and the ability to develop technical solutions. High output, short cycle times: We know what our customers need to remain competitive in the market.

NOZZLE TECHNOLOGY MHT VULCAN II

- Reduced costs and perfect quality for preform production
- Efficient heat transfer
- Longer maintenance intervals
- Customized nozzle tip inlay for all applications



HOTRUNNER TECHNOLOGY MHTOptiRUN

- Thermally verified design
- Naturally balanced melt channels
- Efficient heat utilization
- Reduced heat loss to the environment
- Reduced costs for maintenance
- Reduced energy costs

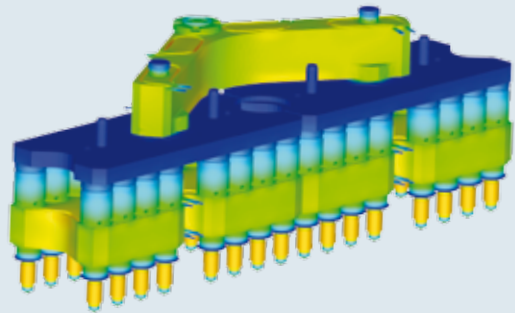

STACK TECHNOLOGY MHThpSTACK

- Advanced cooling design
- Reduced cycle time
- Heat absorption at required spots
- Combinable to most standard stack designs
- Cooling channels closest to contour
- Changeable contour-part (gate insert)



LIGHT WEIGHT SOLUTIONS MHTsaveBASE, MHT21LIGHT

- Bottom of bottle can be made thinner
- Better stretch to blow ratio
- Light weight thread
- Material and energy saving

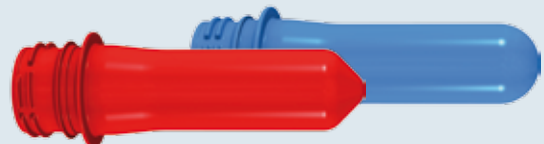

MHTsaveBASE

MHT21LIGHT (3,9 g)



PCO 1810 (5,1 g)

Post Mold Cooling

We offer post mold cooling solutions such as our three or four step take off plate with a newly developed pin ejector.

It is available for all mold types and cavitations. Of course MHT molds also work perfectly well with post mold cooling technologies of other manufacturers (e.g. Husky HyPET, G-Line; Netstal Calitec).

PMC SOLUTIONS MHT COOL-MAX

- PMC technology for all common PET systems
- Excellent alignment of PMC parts for perfect quality
- Very stable double tube system
- Fastest cycle times
- Spring loaded gripper pins available
- 2 to 192 cavities
- Patented air flow technology
- Cooling & part picking combination
- High efficiency by optimized airflow guiding
- Water cooling option (reduced air temperature)

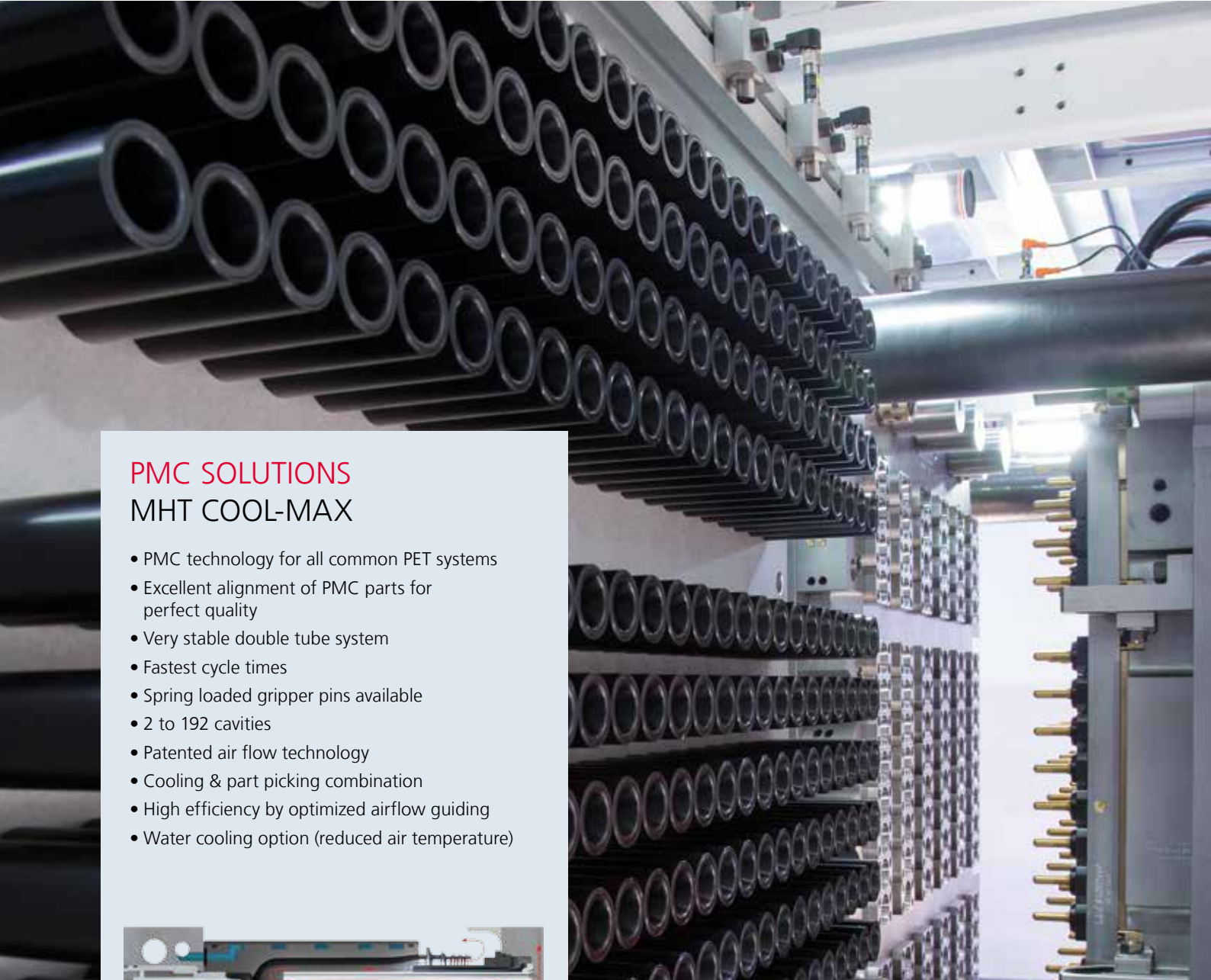
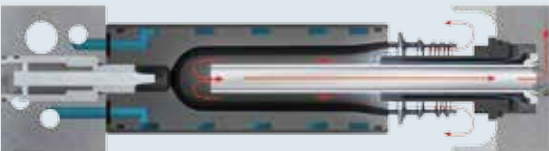



Service

Our commitment does not end after mold delivery – as your partner, we will keep on providing reliable support afterwards. We supply the best possible intensive, active and direct support in a plan covering after-sales and mold service. For example:

NEW MOLDS

- Dimensioning, such as in interface determination
- Application and product consultation
- Mold start-up
- General and application training

MOLD REFURBISHMENTS

- Hot halves
- Cold halves
- Take-out and post-mold cooling devices

MOLD CONVERSIONS

- Weight changes
- Thread changes
- Contour changes
- Weight optimisation
(MHTsaveBASE, MHT21LIGHT)



MHT MOLD & HOTRUNNER
TECHNOLOGY AG



- Precision PET preform molds for all major systems
- Mold sizes up to 192 cavities
- Post mold cooling solutions up to 192 cavities
- Advanced hotrunner and nozzle technology
- Worldwide service

